



## High quality, license-free, ultra-tiny vtx

*Revision 2019-11-15*

The **TBS UNIFY PRO32** is a successor to the most popular line of video transmitters (TBS UNIFY PRO). We have improved the robustness, decreased the size and power consumption, added capability for insane features and perfected the way it is installed in your multirotor. In a nutshell, it's the most comprehensive, future proof, highest quality and overall best VTX line made to date.

### **Key features: Main features across all Unify Pro32 models**

- World's lightest 37ch video transmitter line (custom channels via smartaudio and CRSF)
- Power to Channel calibration for each channel - extremely consistent output power
- 25mW (more power available, requires HAM license\*)
- One button frequency and power setup
- OSD configuration using TBS SmartAudio 2.1 (via Flight controller, TBS Crossfire or PNP PRO OSD)
- LUA support for CRSF users
- u.FL connector, selected models with strain-relief mounting holes (Unify PRO32 nano)
- MMCX connector (Unify PRO32 HV)
- 1-3S input or 2-6S input with 5V output versions available
- Improved noise filtering
- Double noise filtering (Unify PRO32 HV)
- Optimized heat dissipation
- OTA firmware update capability using CRSF
- Solder-on module dimensions available on request



# Specifications

	TBS UNIFY PRO32 5G8 nano	TBS UNIFY PRO32 HV (MMCX)
<b>Input voltage:</b>	1S - 3S LiPo 3V - 13V	2S - 6S LiPo 6V - 36V
<b>Power Output</b>	Input Voltage - LC filter - Output voltage (pass through, following input voltage)	Regulated and filtered 5V / 2A
<b>Extra features:</b>	CleanSwipe PitMode (incl. Support for team racing) Full CRSF capability (Serial commands for external control)	
<b>Software protocol</b>	SmartAudio V2.1 CRSF	
<b>Output Power</b>	14dBm (25mW) 20dBm (100mW*) 26dBm (400mW*)	14dBm (25mW) 20dBm (100mW*) 26dBm (400mW*) 30dBm (1000mW*)
<b>Pit mode</b>	<p><b>Activate:</b> Press power during startup or use Smart Audio V2.1 LED flashes red when enabled</p> <p><b>Disable / Deactivate:</b> Press power for 5 seconds during runtime Or use Smart Audio V2.1</p>	
<b>Pit mode -&gt; flight mode</b>	On-board button, SmartAudio 2.1 or CRSF Command	
<b>Channels:</b>	Band A (8ch), B (8ch), E (5ch) Fatshark 8ch, Race Band 8ch	
<b>Audio on 6.5MHz</b>	No	Yes, built in Microphone
<b>Power consumption</b>	25mW: 210mA 100mW: 280mA 400mW: 390mA	25mW: 90mA - 130mA (22V - 14.8V) 100mW: 120mA - 170mA (22V - 14.8V) 400mW: 180mA - 270mA (22V - 14.8V) 1000mW+: 300mA - 450mA (22V - 14.8V)
<b>Range:</b>	2km (omni)	6km (omni) 80km+ (directional)
<b>Antenna connector:</b>	u.FL high strength	MMCX
<b>Port connector</b>	Through-holes, 2mm pitch	JST-GH 7 pin
<b>Dimensions:</b>	14.5(L) x 13(W) x 3(H) mm	37(L) x 25(W) x 6(H) mm
<b>Weight:</b>	1g	9.2g
<b>Firmware upgrade</b>	Yes Through CRSF (Crossfire etc)	Yes Through USB via TBS Agent Through CRSF (Crossfire etc)
<b>Kit contents:</b>	TBS UNIFY PRO32 NANO u.FL Antenna Silicon Cables pre- tinned	TBS UNIFY PRO32 MMCX to SMA Pigtail JST-GH 7pin Silicon Cable, ends pre- tinned

\* requires HAM license, special unlocking procedure, available on selected models only!



---

# Table of Contents

## [Specifications](#)

### [Table of Contents](#)

### [Button menu control](#)

[Channel select mode](#)

[Band select mode](#)

[Unlock & power select mode](#)

[PitMode](#)

[Save and exit](#)

[Button menu structure](#)

[LED Flash Codes for Channel, Band and Power](#)

[Menu Table](#)

[Channel/ Band - Frequency Table](#)

### [Installation / Mounting](#)

[OSD control via Flight Controllers \(Smartaudio\)](#)

[Control via Crossfire receiver \(CRSF\)](#)

[VTx control via PWM channel \(Only for Unify PRO32 Nano\)](#)

### [Video transmitter pinout](#)

[TBS UNIFY PRO32 5G8 nano](#)

[TBS UNIFY PRO32 HV 5G8](#)

### [Technology showcase](#)

[PitMode](#)

[SmartAudio 2.1](#)

[CRSF](#)

[CleanSwitch](#)

[Force device into bootloader mode](#)

### [Declaration of Conformity](#)

[Good practices](#)



---

## Button menu control

The menu consists of categories and settings. Pressing the button for 3 seconds will toggle between categories, pressing it for a short time toggles between settings. To enter the menu, hold the button for 3 seconds. LED colors will signal the state of the menu, for an overview see the [menu table](#).

### Channel select mode

Enter menu by pressing the button for 3s. Red LED will flash 1 time. Select channels by simple short presses.

### Band select mode

Press button for an additional 3s. Red LED will flash 2 times. Select band by simple short presses.

### Unlock & power select mode

(FOR HAM USERS ONLY!) Press button for 20 to 25 seconds. The Red LED will flash 3 times to confirm. You have unlocked the video transmitter for use with all frequencies (see frequency table below).

**NOTE:** Unlock only works if you are inside the band selection menu

The power select mode is now accessible. Once unlocked, you can select the power level according to the table below. To lock the transmitter, go back into band select menu and press the button for 20 to 25 seconds again.

### PitMode

Pit mode function explained [HERE](#)

### Save and exit

Press button for 3 seconds. Blue LED will turn on, settings are saved and it will exit the menu.



## Button menu structure

For Unify PRO32 HV

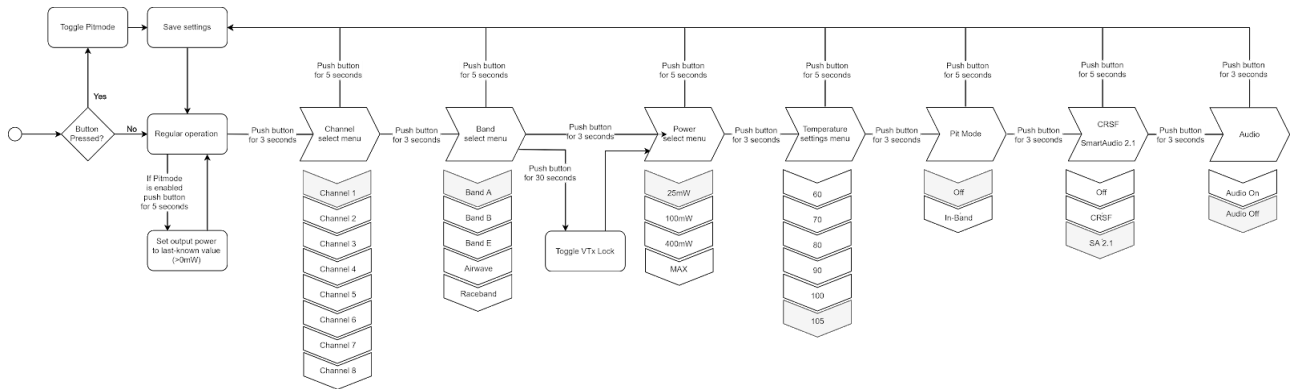

For Unify PRO32 Nano

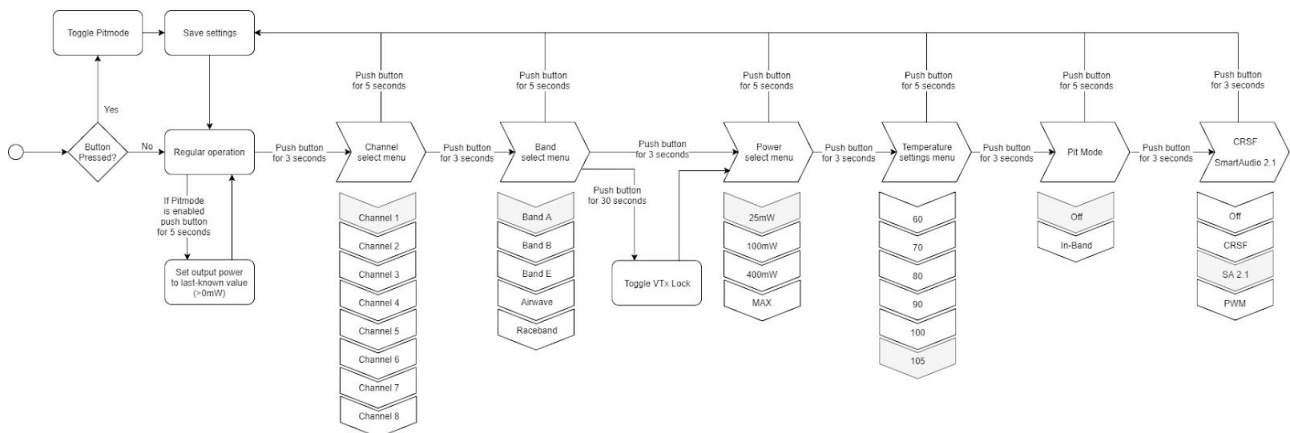

## LED Flash Codes for Channel, Band and Power

The TBS UNIFY PRO32 5G8 signals selected channel, band and power levels using a startup sequence of LED codes. The same sequence is also repeated in the menu to make it unified. First the **RED** LED flashes to indicate the item being shown. One flash for channel, two flashes for band, three flashes for power level. Subsequently, the **BLUE** LED will indicate the value.

<b>Red LED:</b>	Indicate item - Channel, band or power setting
<b>Blue LED:</b>	Indicate value



## Menu Table

RED LED		BLUE LED							
		1x	2x	3x	4x	5x	6x	7x	8x
1x	Channel	1	2	3	4	5	6	7	8
2x	Band	A	B	E	Airwave	Race			
3x	Power Level	25mW	100mW	400mW	1000mW				
4x	Limit Temp.	60	70	80	90	100	105		
5x	PIT Mode	OFF	IN-BAND						
6x	CRSF/SA/PWM	OFF	CRSF	SA	PWM**				
7x*	Audio (Mic)	OFF	ON						

\* Unify PRO32 HV only

\*\* Unify PRO32 Nano only

## Channel/ Band - Frequency Table

Channel	1	2	3	4	5	6	7	8	
Band A	5865	5845	5825	5805	5785	5765	5745	5725	MHz
Band B	5733	5752	5771	5790	5809	5828	5847	5866	MHz
Band E	5705	5685	5665	5645	5885	5905	5925	5945	MHz
Airwave	5740	5760	5780	5800	5820	5840	5860	5880	MHz
Race Band	5658	5695	5732	5769	5806	5843	5880	5917	MHz
PowerLevel	25	100	400	1000+					mW

Grey fields are the default factory setting.

The selections in orange requires HAM license to operate legally. Black selections are only available on special request (custom firmware for large events with prior legal body approval). The video transmitter ensures that you cannot select illegal channels or power levels by accident:

- When controlled by the push button, you will need to confirm having a HAM license by following the steps described above to unlock your video transmitter
- Through the CORE PRO, you are required to enter your HAM license number under the "Callsign" menu before you can access the high power transmission settings and the locked out channels



---

## LED Button Menu Example

For example, Channel 6, Band B, Power of 400mW, default max. Temperature, pit mode off, SA protocol and enabled audio will have the following startup LED code:

- 1x Red and 6x Blue = Channel, 6
- 2x Red and 2x Blue = Band, 2 (=B)
- 3x Red and 3x Blue = Power, 3 (= 400mW)
- 4x Red and 6x Blue = Temperature Limit (105°C)
- 5x Red and 1x Blue = Pit Mode Off
- 6x Red and 3x Blue = Protocol set to Smartaudio
- 7x Red and 2x Blue = Audio set enable using onboard MIC (Unify PRO32 HV only)

Once the Video transmitter has successfully booted up, it will show a constant BLUE for locked state, and a constant RED + BLUE for unlocked state. If the TBS UNIFY PRO32 5G8 is in pit mode, the red light will flash.

## Installation / Mounting

When installing the Unify Pro32, please ensure adequate airflow and - most importantly - heat transfer. This means mounting the Unify Pro32 with a bit of pressure against a flat piece of carbon will give you the best results. Proper mounting will allow the video transmitter to run for extended periods of time while sitting on the ground and without reducing output power. TBS UNIFY PRO32 automatically reduces output power before it reaches critical heat levels.

## OSD control via Flight Controllers (Smartaudio)

Using any Smart Audio V2.1 compatible flight controller simply connect the Smart Audio data pin to a free and supported port on your FC (see pinout below).

For Betaflight users, you can then configure the connected port in Betaflight configurator to Smart Audio V2.1 protocol. Ideally you make sure to get a Betaflight firmware which supports the new SA2.1 (Betaflight >=V3.5.6) rather than the older SA2.0. This way you get access to the new power levels of SA2.1.

You can then start controlling your VTx using any on-board OSD or using LUA scripts on your OpenTX remote control.

## Control via Crossfire receiver (CRSF)

All Unify PRO32 do have a full serial interface which has extended functionality compared to Smartaudio which is just a onewire protocol.

CRSF needs two data connections:

Crossfire Receiver (CRSF TX) → Unify PRO32 (CRSF RX)

Crossfire Receiver (CRSF RX) ← Unify PRO32 (CRSF TX)

The required ground connection is usually given already as both devices share the same ground.

Instead of Crossfire RX you can also connect it to any other CRSF compatible device.

Enable CRSF on the VTx by changing it with the [push button menu](#). To get CRSF on more than one output of the receiver, you need to flash it with fw 2.93 or later. If you use a FC as well, set output 4 to CRSF TX and connect the wires according to the following graphic on the [VTx pinout](#).

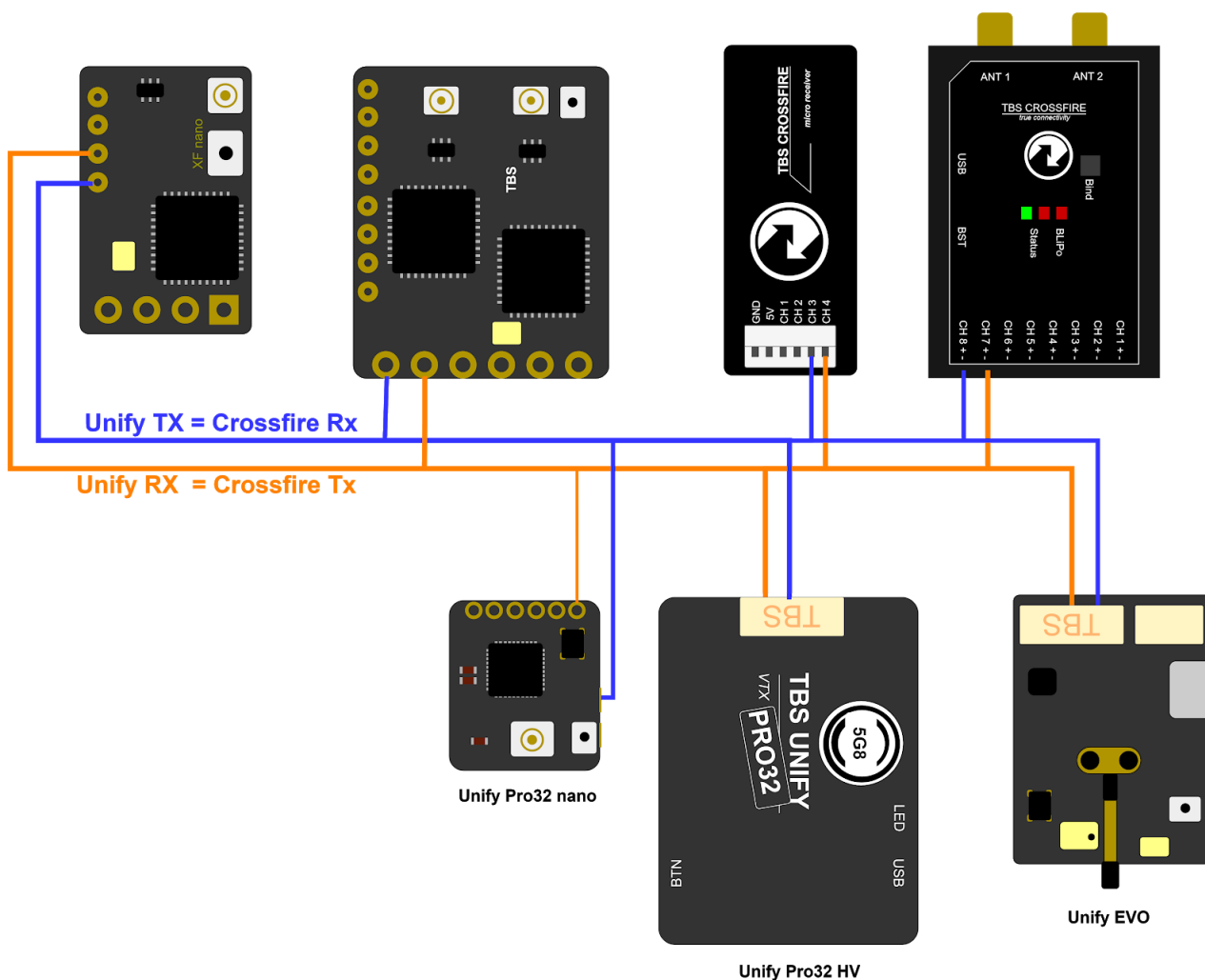

If you have set up everything correctly, you should see the Unify32 in the Lua script, Tango device menu or



---

the Crossfire oled display (fw 3.21 or later required).

To update the UnifyPro32 and set it up by the Agent X (ota) you need to install the Crossfire tx in your radio, power it up and connect the tx by usb to the Agent X. Now turn on your receiver and the VTx and wait for a moment. The receiver and the UnifyPro32 will become online and you can set it up as you like.

If you want to use PitMode on a switch, you need to set the channel number of the switch you want to use for it in the "Channel Map" menu

## **VTx control via PWM channel (Unify PRO32 Nano only)**

This is a simplified method to use a single channel as a button to modify the VTx channel, depends on the radio controller you may need to reverse the channel output. Connect the PWM output from your receiver to the Smartaudio/CRSF RX pin. The operations are as follows:

- Short push the button to increase channel.
- Long push the button ( >3s ) to increase band.
- Longer push the button ( >5s ) to reset VTx channel to A1.



## Video transmitter pinout

### TBS UNIFY PRO32 5G8 nano

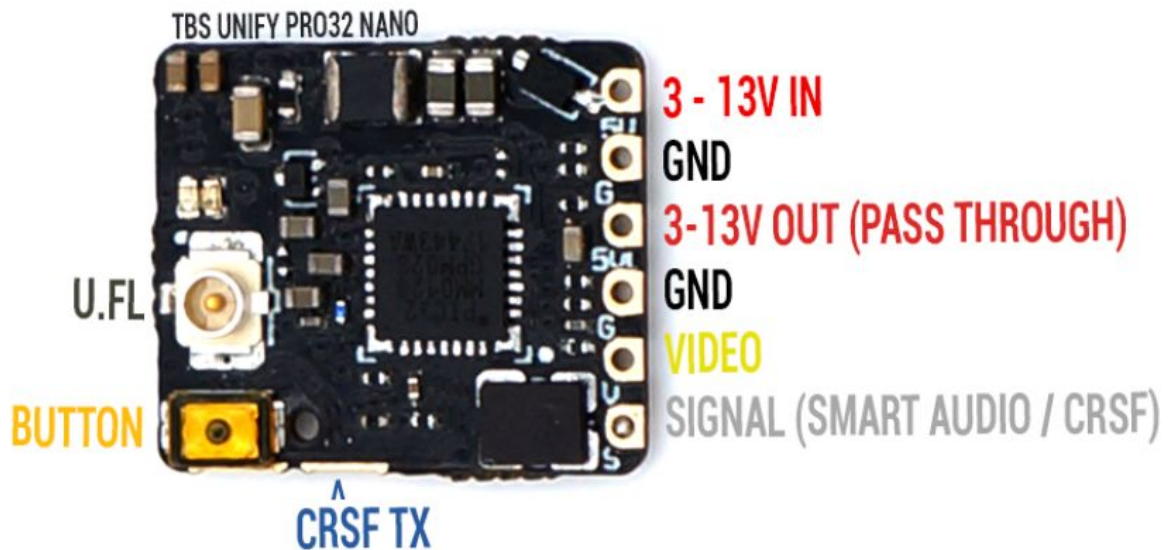

The UNIFY PRO32 5G8 Nano comes with pre installed silicon wires for easy installation in your build. There is a filtered 3-13V input with a pass through output for your camera or other devices.

The ideal camera for this VTx is the [TBS TINY CAMERA](#). This Camera is able to supply 5V to the VTx which is required for any 1S Setup.

#### ATTENTION!

- Please take care when soldering to the tabs, do not solder with temperatures higher than 350°C for more than 3-5sec.
- For remote control the VTx channels we suggest to use SmartAudio or CRSF interface. The tactile button is very fragile, do not use hard and pointy objects such as needles to change channels to prevent permanent damage to the button.

## TBS UNIFY PRO32 HV 5G8

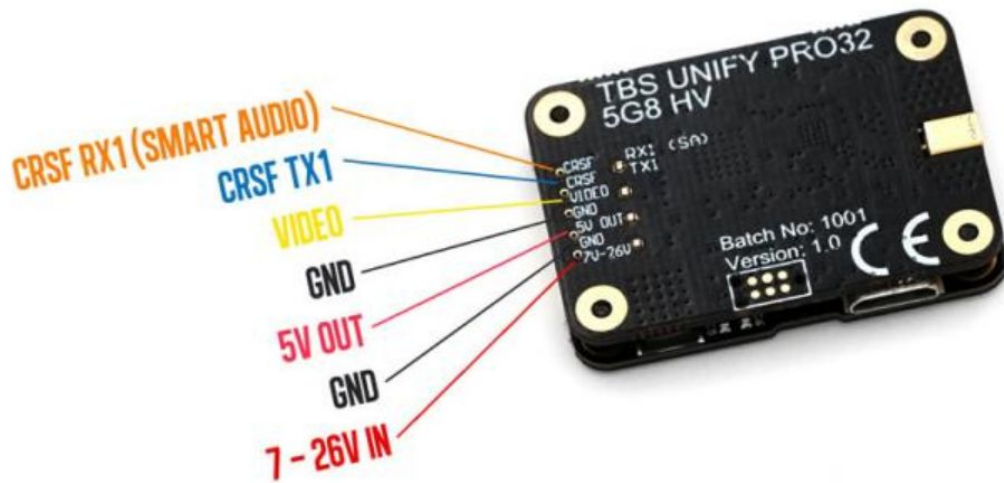

The UNIFY PRO32 5G8 HV comes with a cable assembly with silicon wires for easy installation in your build. There is a filtered 5V output for your camera.

The installed Step Down converter is a new, more powerful DCDC and is capable of powering most 5V cameras on the market.



---

## Technology showcase

### PitMode

PitMode is a mode where the video transmitter only runs on an incredibly low output power. This prevents interference with others at events, while still allowing a minimum of visibility for emergency last-minute setting changes.

With the TBS UNIFY PRO32 line, Pit Mode has been slightly modified in behavior. The main button on the video transmitter is used to toggle pitmode flag at power-up, and SmartAudio / CRSF can modify this flag as well. Smart Audio can also enter pit mode during runtime using the power setting 0mW, which will not modify the flag (the VTx will never power up at the 0mW power setting). To leave pitmode during operation, simply set your desired power setting using Smart Audio, CRSF or the button menu.

### SmartAudio 2.1

SmartAudio is a protocol developed by TBS for OSD to VTx communication. SmartAudio is a single-wire UART protocol, running over the Audio-wire. All newer generation OSDs at TBS, and all UNIFY PRO series VTx, and all modern flight controllers support SmartAudio!

With the UNIFY PRO32 line we have launched SmartAudio V2.1. Over the regular SmartAudio, it changed control for PitMode in operation to a switch(on / off) rather than a flag that is refreshed on reboot.

If you are an OSD or VTx developer interested in adding support for SmartAudio, please check our [SmartAudio specification](#). SmartAudio is a free-to-use protocol. If you'd like to use "TBS SmartAudio" in your marketing, you may contact us for licensing options:

- <http://team-blacksheep.freshdesk.com/>

### CRSF

CRSF is a protocol designed by Team BlackSheep and championed through the TBS Crossfire remote control system. It has been integrated into most popular remote controls, is an incredibly high bandwidth (low latency) full duplex, serial data transmission protocol. It comes with native functionality such as OTA (over the air) firmware upgrades, localized configuration menus and a smart routing protocol.

With the advent of the TBS UNIFY PRO32, for the first time in FPV history does a VTx now support this functionality. We can configure channel, output power and pitmode settings. Additionally, software updates via the TBS Crossfire platform are now possible.



## CleanSwitch

A new feature introduced with the TBS UNIFY PRO 5G8 is CleanSwitch. When video transmitters power up or change frequency, they usually send a burst across the entire band which disturbs fellow flying pilots. All UNIFY PRO32 5G8 video transmitters will remain in their lowest power output (less than 0.1mW) while changing channels and powering up. This ensures interruption-free racing, even with multiple video transmitters changing channels, or powering up. Despite all this, TBS UNIFY PRO & EVO are still the fastest video transmitter on power up - thus ensuring it is the perfect choice for any application where quick channel changes are a necessity!

## Force device into bootloader mode

In some rare cases it can be required to force the device into bootloader mode. This can be done by simply bridge 2 pads on the unit then power up. For regular operation this will not be required.

Please follow the diagram below:

- TBS Unify Pro32 HV (MMCX)

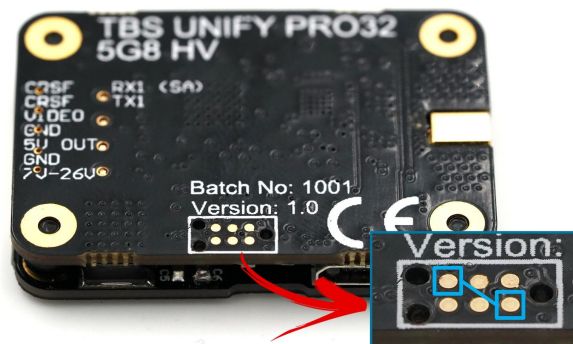

- TBS Unify Pro32 Nano

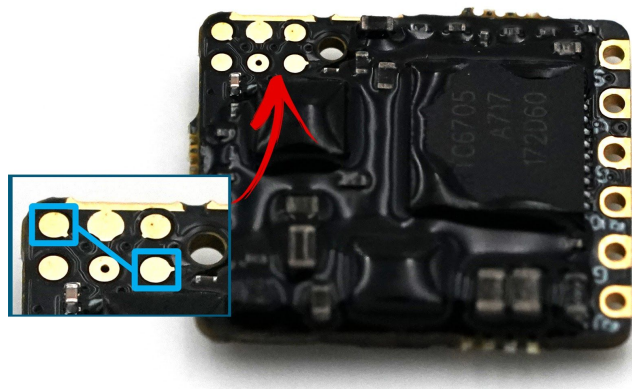

# Declaration of Conformity



## EU - DECLARATION OF CONFORMITY

We affirm that the electrical equipment manufactured by us complies with the requirements of the R&TTE Directive 1999/5/EC

**Manufacturer:**

TBS Avionics Co Ltd  
44-46 Hung To Rd, 12/F  
Unit 1204, Century Centre  
Kwun Tong, Hong Kong

Tel: +852 5685 2608  
Fax: +852 5685 2608  
E-Mail: rpirker@team-blacksheep.com

**Description of the appliance:**

5G8 System

**Trade name and model of appliance:**

TBS Unify Pro32 Nano 5G8 (A-TBSS-UPN32)  
SNR 0741587432661

**Applicable Standard (s):**

- EN 300 440-1 V1.6.1; EN 300 440-2 V1.4.1 Article 3.2
- EN 301 489-1 V1.9.2; EN 301 489-3 V1.6.1 Article 3.1b
- EN 62311:2008 Article 3.1(a) - Health
- EN 60950-1:2006+A11:2009+A1:2010+A12:2011+A2:2013 Article 3.1a Safety

Assumption of conformity is based on the application of the harmonized standards and, when applicable or required, a European Community notified body certification, as shown in the attached schedule.

January 24th, 2018



Raphael Pirker, CEO  
TBS Avionics Co Ltd.







## EU - DECLARATION OF CONFORMITY

We affirm that the electrical equipment manufactured by us complies with the requirements of the R&TTE Directive 1999/5/EC

**Manufacturer:**

TBS Avionics Co Ltd  
44-46 Hung To Rd, 12/F  
Unit 1204, Century Centre  
Kwun Tong, Hong Kong

Tel: +852 5685 2608  
Fax: +852 5685 2608  
E-Mail: rpirker@team-blacksheep.com

**Description of the appliance:**

5G8 System

**Trade name and model of appliance:**

TBS Unify Pro32 HV (MMCX) (A-TBSS-UPH32)  
SNR

**Applicable Standard (s):**

- EN 300 440-1 V1.6.1; EN 300 440-2 V1.4.1 Article 3.2
- EN 301 489-1 V1.9.2; EN 301 489-3 V1.6.1 Article 3.1b
- EN 62311:2008 Article 3.1(a) - Health
- EN 60950-1:2006+A11:2009+A1:2010+A12:2011+A2:2013 Article 3.1a Safety

Assumption of conformity is based on the application of the harmonized standards and, when applicable or required, a European Community notified body certification, as shown in the attached schedule.

January 24th, 2018



Raphael Pirker, CEO  
TBS Avionics Co Ltd.



---

## Good practices

We have compiled a list of all of practices which have been tried and tested in countless environments and situations by the TBS crew and other experienced FPV pilots.

Follow these simple rules, even if rumors on the internet suggest otherwise, and you will have success in FPV.

- Start with the bare essentials and add equipment one step at a time, after each new equipment was added to proper range- and stress tests.
- Do not fly with a video system that is capable of outperforming your R/C system in terms of range.
- Do not fly with a R/C frequency higher than the video frequency (e.g. 2.4GHz R/C, 900MHz video).
- Monitor the vitals of your plane (R/C link and battery). Flying with a digital R/C link without RSSI is dangerous.
- Do not use 2.4GHz R/C unless you fly well within its range limits, in noise-free environments and always within LOS. Since this is most likely never the case, it is recommended to not use 2.4GHz R/C systems for longer range FPV.
- Do not fly at the limits of video, if you see noise in your picture, turn around and buy a higher-gain receiver antenna before going out further.
- Shielded wires or twisted cables only, anything else picks up RF noise and can cause problems.
- When using powerful R/C transmitters, make sure your groundstation equipment is properly shielded.
- Adding Return-To-Home (RTH) to an unreliable system does not increase the chances of getting your plane back. Work on making your system reliable without RTH first, then add RTH as an additional safety measure if you must.
- Avoid powering the VTx directly from battery, step-up or step-down the voltage and provide a constant level of power to your VTx. Make sure your VTx runs until your battery dies.
- Do not power your camera directly unless it works along the complete voltage range of your battery. Step-up or step-down the voltage and provide a constant level of power to your camera. Make sure your camera runs until your battery dies.
- A single battery system is safer than using two dedicated batteries for R/C and FPV. Two batteries in parallel even further mitigate sources of failure.
- For maximum video range and “law compatibility”, use 2.4GHz video with high-gain antennas.
- When flying with R/C buddies that fly on 2.4GHz, or when flying in cities, it is perfectly possible to use 2.4GHz video provided you stick to the channels that do not lie in their band (CH5 to CH8 for Lawmate systems, available from TBS).
- Do not use diversity video receivers as a replacement for pointing your antennas, diversity should be used to mitigate polarization issues.





- 
- Improving the antenna gain on the receiver end is better than increasing the output power (except in RF-noisy areas). More tx power causes more issues with RF on your plane. 500mW is plenty of power!
  - Try to achieve as much separation of the VTx and R/C receiver as possible to lower the RF noise floor and EMI interference.
  - Do not buy the cheapest equipment unless it is proven to work reliably (e.g. parts falling off, multitudes of bug fix firmware updates, community hacks and mods are a good indicator of poor quality and something you do NOT want to buy for a safe system). Do due diligence and some research before sending your aircraft skyward.

Manual designed by ivc.no, written by TBS and ivc.no.



**TEAM BLACKSHEEP**  
SERIOUS TOYS

